



# HAYTER

MAKERS OF THE FINEST MOWERS

## *Harrier 48*

*CODES*

*490G & 491G*



## OWNER'S HANDBOOK

Original Version (EN)  
ISSUE: 04.10.11

PART NUMBER: 111-3880 (C)

# CONTENTS

<b>Contents</b>	<b>2</b>
<b>Introduction</b>	<b>3</b>
<b>Specifications / Main Features</b>	<b>4</b>
<b>Safety Precautions</b>	<b>5 - 6</b>
- Safety Alert Symbol	5
- Training	5
- Preparation	5
- Safety Symbols	5
- Operation	5 - 6
- Maintenance & Storage	6
- Control Symbols	6
<b>Assembling the Mower Before First Use</b>	<b>7</b>
- Delivery Checklist	7
- Handlebar	7
- Grassbag Assembly	7
- Prevent Engine Damage	7
- Oil Type	7
- Check Oil Level	7
- Fuel Type	7
<b>Operating The Mower</b>	<b>8 - 10</b>
- Controls	8
- Starting	8
- Electric Start	8
- Engaging Cutterblade Drive	8
- Forward Travel	8
- Reverse Travel	9
- Turning	9
- Stopping	9
- Slopes	9
- Height of Cut	9
- Before Mowing	9

- Grassbag	9
- Without Grass Collection	9
- Heavy Growth	9
- Friction Disc	10
- Non-Grassed Areas	10
- Maintenance Schedule	10

<b>Mower Maintenance</b>	<b>11 - 14</b>
- Carburettor Adjustments	11
- Oil Service	11
- Air Cleaner Service	11
- Spark Plug Service	11
- Keeping Engine Clean	11
- Grassbag	11
- Deck Housing	12
- Securing Nuts and Bolts	12
- Clutch Cable Adjustment	12
- Lubrication	12
- Cutterblade Removal	12
- Cutterblade Assembly	13
- Cutterblade Sharpening	13
- Storage	13
- Battery Charging	14

<b>Lawn Care Calendar</b>	<b>15</b>
<b>Trouble Shooting</b>	<b>16</b>

<b>Warranty</b>	<b>17</b>
-----------------	-----------

<b>Notes</b>	<b>17 - 19</b>
--------------	----------------

<b>Customer Info / Service Records</b>	<b>20</b>
--	-----------

# INTRODUCTION

Thank you for purchasing a Hayter mower. The following pages are designed to help you gain safe and efficient service from your machine.

**IMPORTANT:** This 'Owners Handbook' should be regarded as part of the mower as it gives essential information regarding mower safety, operation, maintenance and specifications. Read and understand this handbook prior to operating your mower for the first time. Make sure you are familiar with all the controls and points of regular maintenance. If you have any doubts, consult your local Hayter authorised dealer who will be pleased to give you assistance.

**IMPORTANT:** This mower is designed solely for use in a domestic grass cutting environment. Use in any other way is considered as contrary to the intended use. Compliance with and strict adherence to the conditions of operation, service and repair as specified in this handbook also constitute essential elements of the intended use. This mower should be operated, serviced and repaired only by persons who are familiar with its particular characteristics and who are acquainted with the relevant safety procedures.

The safety precautions listed in this handbook and all other generally recognised regulations on safety must be observed at all times.

Use of non standard parts or any arbitrary modifications carried out on this machine may relieve Hayter Limited of liability for any resulting damage or injury.

Hayter mowers are robustly constructed and designed for efficient economical performance under normal mowing conditions. Correct operation and maintenance will ensure a long and satisfactory service life. Prior to despatch from our factory every effort is made to ensure that your mower is delivered in perfect condition.

Throughout this handbook all references to **left** and **right** are as viewed from behind the handlebar, in the direction of forward travel.

This handbook is based on information available at the time of publication.

HAYTER LIMITED reserve the right to amend product specifications without prior notification.

*For a full range of products and to locate your nearest authorised sales stockist, service or parts dealer please visit our website at [www.hayter.co.uk](http://www.hayter.co.uk)*

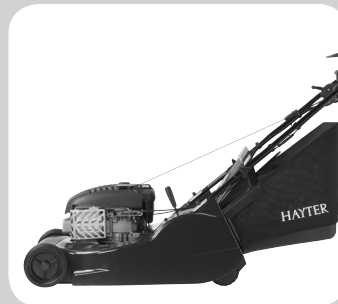

# SPECIFICATIONS / MAIN FEATURES

Code	490	491
Engine	Briggs & Stratton	Briggs & Stratton
Engine type	Series 650	Series 650
Engine / Cutterbar Speed	2750 rpm	2750 rpm
Fuel type	Unleaded petrol	Unleaded petrol
Fuel capacity	1 litre	1 litre
Oil type	SAE 30 engine oil	SAE 30 engine oil
Oil sump capacity	0.6 litres	0.6 litres
Cutting width	480mm	480mm
Cutting height	13 - 60mm	13 - 60mm
Overall dimensions	1080 x 507 x 1510mm	1080 x 507 x 1510mm
Weight	46.5 Kg	50.5 Kg

1. Spark Plug Lead.
2. Engine Cover.
3. Air Cleaner.
4. Fuel Filler Cap.
5. Oil Filler Cap and Dipstick.
6. Serial No. Label.
7. Handlebar Securing Knob.
8. Engine Start-Grip.
9. Electric Start (491 only).
10. Key (491 only).
11. Engine Stop Lever.
12. Handlebar.
13. Ground Drive Clutch Lever.
14. Variable Speed Control (see note)
15. Grassbag Assembly.
16. Rear Deflector.
17. Height Of Cut Adjuster.
18. Battery (491 only).
19. Exhaust Guard.

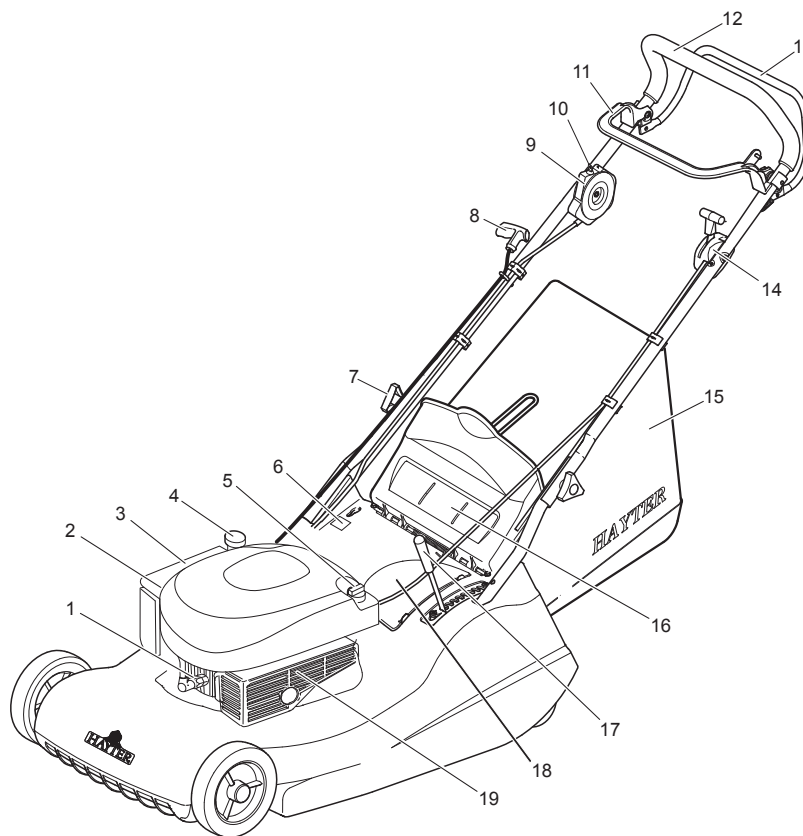

**Note:** Item 14 should only be operated whilst the engine is running or the cable will be damaged.

# SAFETY PRECAUTIONS

## Safety Alert Symbol

This safety alert symbol indicates important safety messages. When you see this symbol be alert to the possibility of injury. Carefully read the following and inform others.

Your mower is perfectly safe if used correctly. Failure to observe the following precautions may result in serious injury.

## Training

Before using the mower read the owners handbook carefully. Pay particular attention to the safety precautions. Ensure that you are familiar with the controls and the proper use of the equipment. Learn how to stop the mower quickly in an emergency.

Never allow children or people unfamiliar with these instructions to use the mower. Local regulations can restrict the age of the operator.

Never mow while people, especially children, or pets are nearby.

Keep in mind that the user is responsible for accidents or hazards occurring to other people or their property.

## Preparation

While mowing, always wear substantial footwear and long trousers. Do not operate the equipment when barefoot or wearing sandals.

Thoroughly inspect the area where the mower is to be used and remove all objects which may be thrown by the machine.

**WARNING:** Petrol is highly flammable:

- store fuel in containers specifically designed for this purpose.
- refuel outdoors only and do not smoke while refuelling;
- add fuel before starting the engine. Never remove the cap of the fuel tank or add petrol while the engine is running or when the engine is hot;
- if petrol is spilled, do not attempt to start the engine but move the machine away from the area of spillage and avoid creating any source of ignition until the petrol vapours have dissipated;
- replace all fuel tank and container caps securely.

Replace faulty silencers.

A damaged cutterblade or loose fixing bolt are major hazards. Before use, always visually inspect the cutting mechanism to ensure that it is in good condition. A damaged cutterblade must be replaced immediately with a

genuine Hayter replacement part.

## Operation

Do not operate the engine in a confined space where exhaust fumes (carbon monoxide) can collect.

Always pull the starter cord slowly until resistance is felt. Then pull the cord rapidly to avoid kickback and prevent hand or arm injury.

Mow only in daylight or good artificial light.

Avoid using the machine on wet grass, where feasible. Always be sure of your footing on slopes.

Walk, never run.

Do not mow excessively steep slopes of more than 20° and mow across the face of slopes, never up and down. Exercise extreme caution when changing direction. Use extreme caution when reversing or pulling the mower towards you.

Always replace worn or faulty parts with genuine Hayter parts.

This machine contains spring loaded assemblies which could cause a hazard when disassembled and reassembled. Maintenance should only be carried out by a Hayter authorised dealer.

## Safety Symbols



Safety Alert - Be aware to the possibility of injury.



Stop engine and remove spark plug lead before working on the mower.



Carefully read the Owners Handbook before using the machine.



Danger of being hit by thrown objects.

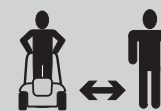

Keep bystanders at a safe distance from the mower.



Danger of severing toes or fingers in cutting mechanism.

# SAFETY PRECAUTIONS

## Operation *cont*

If the machine has to be tilted for transportation when crossing surfaces other than grass, and when transporting the machine to and from the area to be mowed. Stop the blade (s) by releasing the engine stop lever, ensure that the blade (s) have stopped before tilting the mower.

Never operate the machine with defective guards, or with out safety devices, for example deflectors and/or grass bag in place.

Do not change the engine governor settings or overspeed the engine.

Start the engine carefully, with feet well away from the cutterblade and always disengage the rear roller drive clutch before starting the engine.

Do not tilt the mower when starting the engine.

Do not start the engine when standing in front of the discharge chute.

Do not put hands or feet near or under rotating parts.

Never pick up, carry the machine or lift the rear deflector while the engine is running.

Never touch the exhaust/exhaust guard or cooling fins when the engine is hot.

### Stop the engine and disconnect the spark plug lead:

- Before clearing blockages or unclogging the discharge chute.
- Before cleaning/checking or working on the machine.
- After striking a foreign object. Inspect the machine for damage and ensure necessary repairs are made before re-starting and operating.
- If the machine starts to vibrate abnormally (check immediately).

### Stop the engine:

- Whenever you leave the mower.
- Before refuelling.

## Maintenance & Storage

Keep all nuts, bolts and screws tight to ensure that the equipment is in safe operating condition. Frequently check fuel lines and fittings for cracks or leaks and replace if necessary.

Inspect the exhaust periodically and replace if worn or leaking.

Never store the mower with petrol in the tank within an

enclosed area where fumes may reach an open flame or spark.

Allow the engine to cool before storing in any enclosure.

To reduce the fire hazard, keep the engine and the surrounding deck area free of grass, leaves, or excessive grease.

Check the rear deflector and grassbag frequently for wear or deterioration.

Replace worn or damaged parts for safety.

If the fuel tank has to be drained, this should be done outdoors and when the engine is cool.

Wear strong work gloves when removing and reassembling the cutterblade.

## Control Symbols

(Code 491 only)



Engine Stop



Engine Start



Height of Cut Adjustment

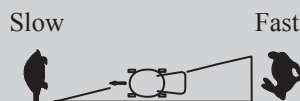

Variable Speed Control



# ASSEMBLING THE MOWER BEFORE FIRST USE

## Delivery Checklist

Remove the mower from the packaging and check that the following items have been supplied correctly. If any items are missing contact, your local Hayter dealer.

1. Engine Handbook.
2. Grassbag.
3. Charger (491)
4. Ignition Key (491)
5. Parts list/D of C
6. Warranty Reg Card.

To prevent accidents cut off the long ribbon attached to the grassbag and discard. (Refer fig.1)

**(491 Only) Note: Prior to first use please fully charge the battery for 14 hours. (Refer to battery charging)**

## Handlebar

Unscrew the handlebar securing knobs sufficiently to allow the handlebar to pivot. Hold the engine stop lever in towards the handlebar and unfold the handlebar to the operating position, before releasing. (Refer fig.2)  
Tighten both handlebar knobs to secure in position.

**Take care to ensure that the control cables do not become snagged at the pivot point.**

## Grassbag Assembly

Before first use assemble the grassbag and frame. Slide the frame (1) into the grassbag (2), ensuring that the han-

dle is above the grassbag as shown. Attach plastic clips (A), (B), (C) and (D) to the grassbag frame. (Refer fig.3)

Raise the rear deflector, lower the grassbag and hook in position. Lower the deflector to rest on the grassbag.

## Prevent Engine Damage

**To prevent engine damage the engine is shipped without oil or petrol. The engine must be filled with the correct grade of oil and petrol before starting the engine. (Refer fig.4)**

## Oil Type

Always use high quality detergent oil classified SAE 30 oil. Never use additives with recommended oil.  
To prolong the life of your engine it is important that the oil is changed after the first 5 hours of use - Refer to 'Maintenance Schedule'.

## Check Oil Level

Clean around the oil filler cap before removing. With the mower on a level surface, unscrew and remove the oil filler - dipstick. Wipe oil from it with a clean cloth. Screw the oil filler - dipstick back in place, then unscrew and remove it to check the oil level. (Refer fig.5)  
**The oil level is correct when it is at the full mark on the dipstick. DO NOT OVERFILL. (Refer fig.5)**

## Fuel Type

Always use clean, fresh unleaded petrol. Purchase fuel in quantities that can be used within 30 days. Never mix oil with petrol. For added engine protection Briggs & Stratton recommend the use of their fuel additive which is available from an authorised Briggs & Stratton service dealer.

**Fill to base of neck to allow for fuel expansion. Do not overfill the fuel tank. (Refer fig.6)**

Fig. 1

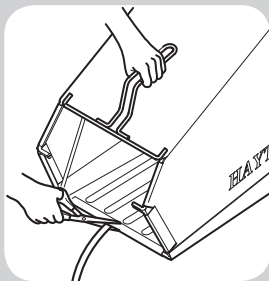

Fig. 2

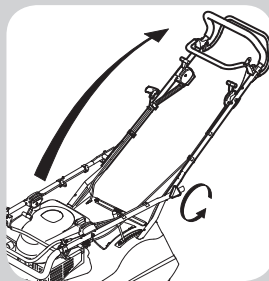

Fig. 3

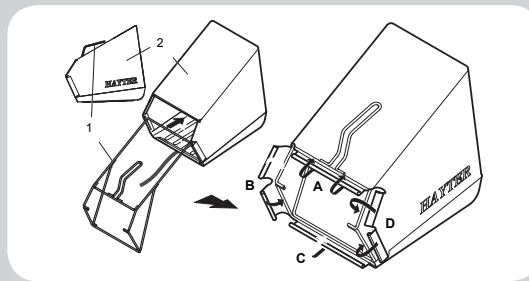

Fig. 4



Fig. 5

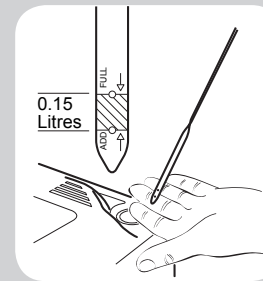
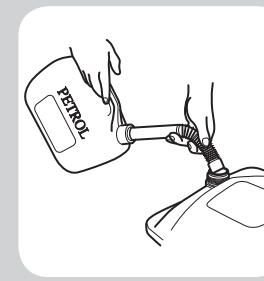

Fig. 6



# OPERATING THE MOWER

## Controls

Operate all control levers several times and ensure that the cables move freely. Check that the engine stop and ground drive clutch levers return freely to their rest position when released. (Refer fig. 7)

**IMPORTANT: To avoid damage to the cable the Variable speed Control should only be operated whilst the engine is running.**

## Starting (490 only)

Stand behind the mower and hold the handlebar together with the engine stop lever with your left hand. With your right hand hold the engine start - grip and pull slowly until resistance is felt, release, then pull rapidly to crank the engine. Carefully return the start grip to the storage position when the engine starts. (Refer fig.8)

If the engine does not start after 3 attempts - Refer to "Trouble Shooting".

The engine stop lever must be held firmly against the handlebar to start and keep the engine running. If the engine stop lever is released the engine will stop.

**To prevent damage never pull the engine start grip when the engine is running.**

## Electric Start (Code 491 only)

Stand behind the mower and hold the handlebar together with the engine stop lever. Turn the ignition key in a clockwise direction and hold in position to crank the engine. When the engine starts release the key. (Refer fig.9)  
**Note:** Cranking the engine for more than 15 seconds in any one minute can damage the starter motor.

**If necessary the engine can be started manually without using the ignition switch. To prevent engine damage do not operate the ignition key when the engine is running.**

## Forward Travel

Hold the handlebar and operate the ground drive clutch lever to power the mower in a forward direction. (Refer fig.10)

When the ground drive clutch lever is disengaged the mower may be pushed. This feature is useful when mowing in confined areas.

Ground speed may be adjusted by operating the variable speed control. Push forward to slow down and pull back to speed up.

Only operate the lever with the engine running to prevent damage.

If the engine stop lever is released the engine will stop.

## Reverse Travel

Release the ground drive clutch lever. Hold and pull against the handlebar with both hands to reverse the mower.

## Turning

To make a wide turn steer the mower with the handlebar in the direction required.

To make a tight turn release the ground drive clutch lever, apply downward pressure on the handlebar to raise the front wheels just above ground level and steer in the required direction.

**To prevent accidents do not raise the front of the mower excessively when making a turn. Never raise the rear of the mower when the engine is running.**

## Stopping

Release the ground drive clutch lever and release the engine stop lever.

**Emergency stop:** Release both ground drive clutch lever and engine stop lever together. **If the engine fails to stop, disconnect the spark plug lead. (Refer fig.11)**

Fig. 7

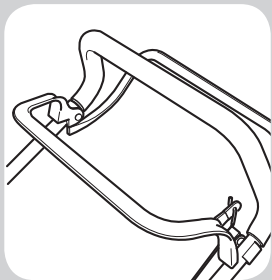

Fig. 8

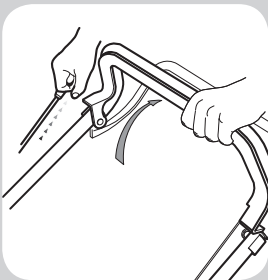

Fig. 9

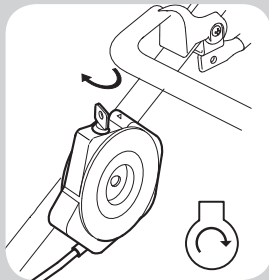

Fig. 10

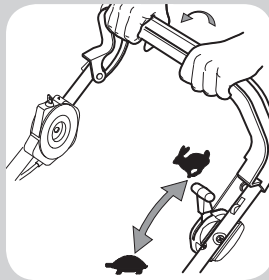
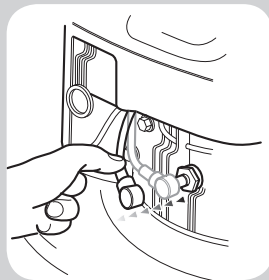

Fig. 11





# OPERATING THE MOWER

## Slopes

To prevent engine damage do not use the mower on slopes greater than 20 degrees. (Refer fig.12)

## Height Of Cut

**To adjust the height of cut:** Grip the lever and pull sideways to disengage it from the locking notch, then push forwards to lower or pull backwards to raise the height of cut. Finally release the lever at the required position and ensure it locks firmly into one of the eight setting notches.

Always select a height of cut to suit operating conditions. Aim to prevent engine overloading and blockages by avoiding low cuts in long grass conditions. Be prepared to make two cuts when the grass is long. (Refer fig.13)

## Before Mowing

**To prevent accidents, thoroughly inspect the area and remove all objects which when contacted by the mower cutterblade could become dangerous projectiles. Inspect the area for hidden obstructions which when contacted by the cutterblade could risk health and safety or result in damage to the mower. Remember the location of these obstructions and ensure that you mow around them. (Refer fig.14)**

## Grassbag

Raise the rear deflector and lift the grassbag and lower the rear deflector to rest against the rear of the mower.

To empty the grassbag, pour out the grass clippings and shake the grassbag vigorously to clean the airways. Good grass collection depends on good air flow through the grassbag. When collecting grass clippings it is important that the grassbag is emptied regularly to prevent blockages and engine overloading. (Refer fig.15)

## Without Grass Collection

Remove the grassbag and operate the mower with the rear deflector in the closed position. (Refer fig.16)

## Heavy Growth

Areas of heavy growth should be mown without collecting the clippings. If collection is required, first mow the area without the grassbag at the maximum height of cut setting. Allow the grass clippings to dry out and then mow the area at the maximum height of cut setting with the grassbag fitted. Reduce the height of cut and mow the area again as necessary until the required finish is obtained.

To prevent damage to your lawn do not remove more than one third of grass height in one cut. (Refer fig.17)

Fig. 12

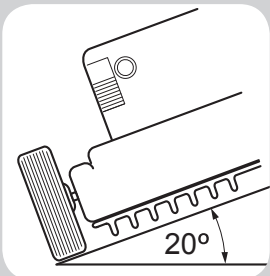

Fig. 13

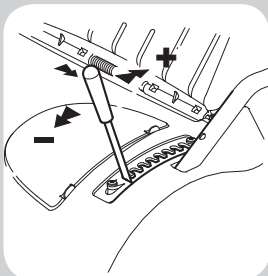

Fig. 14

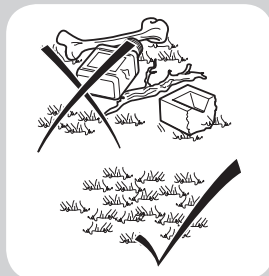

Fig. 15

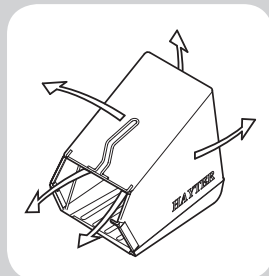

Fig. 16

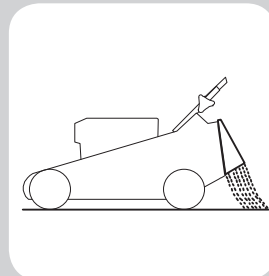
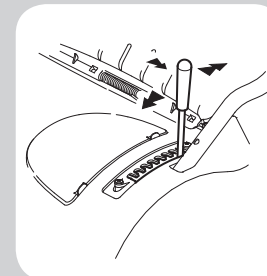

Fig. 17



# OPERATING THE MOWER / MAINTENANCE SCHEDULE

## Friction Disc

The cutterblade is driven by the engine via a friction disc to help prevent damage occurring to the engine crankshaft and cutting mechanism when a hidden obstruction or overload is encountered. (Refer fig.18)

**Always stop the engine when a hidden obstruction or excessive vibration is encountered. Disconnect the spark plug lead and examine the cutting mechanism. ALWAYS replace a damaged cutterblade - Refer to "Maintenance".**

## Non Grassed Areas

When moving the mower across non-grassed areas, stop the engine and set the mower to the maximum height of cut to protect the cutting mechanism. (Refer fig.19)

## Maintenance Schedule

Follow the hourly or calendar intervals, whichever occurs first. More frequent service will be required if working for prolonged periods under dusty, dry conditions, or when airborne debris is present or after extensive operation cutting tall, dry grass.

### First 5 Hours

- After the very first five hours change the engine oil
- Adjust the autodrive clutch cable

### Daily

- Check the oil level
- Remove grass debris from around the engine, exhaust/exhaust guard, air ways in the top cowl, underside of the deck housing and from the grassbag and check for signs of damage.
- Check the condition of guards and safety devices.
- Check condition of cutterblade.

### 25 Hours Or Every Season

- Change the engine oil if continuously operating under heavy load or high ambient temperature.
- Service the air cleaner.
- Lubricate wheels, pivot points and linkages and grease the inner control cables at point of entry and exit from their outer casing.
- Check the clutch cable adjustment.
- Sharpen the cutterblade.

### 50 Hours Or Every Season

Change the engine oil.

### 100 Hours Or Every Season

- Clean the engine cooling system. Clean more often under dusty conditions or when airborne debris is present or after prolonged operation whilst cutting tall, dry grass.
- Replace the spark plug.

## Engine Detail (Refer fig.20)

Fig. 18

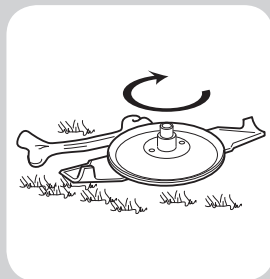

Fig. 19

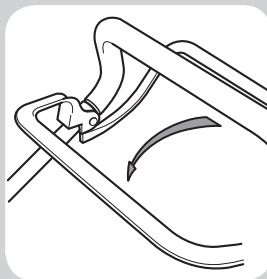
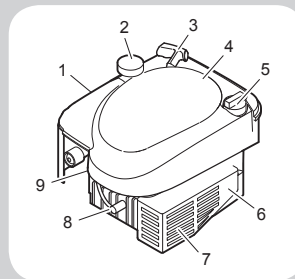

Fig. 20



1. Air Cleaner
2. Fuel Cap
3. Start Grip
4. Cover
5. Oil fill/Dipstick
6. Exhaust Guard
7. Exhaust
8. Spark Plug / Lead
9. Carburettor

# MOWER MAINTENANCE

## Carburettor Adjustments

Should only be made by an authorised Briggs & Stratton dealer. Under no circumstances should the engine be adjusted to run at a speed in excess of that shown on the Declaration of Conformity.

## Oil Service

Check the oil level daily before starting the engine and ensure that the correct oil level is maintained. Refer to 'Before Starting the Mower' for oil checking and filling instructions.

Change the engine oil after the first 5 hours of operation and thereafter according to the 'Maintenance Schedule':-

1. Drain fuel by running the engine until the fuel tank is empty.
2. Remove the spark plug lead.
3. Allow the engine to cool.
4. Drain the oil while the engine is warm (not hot)
5. Tip the mower over on to its left hand side thus ensuring that the air cleaner is kept uppermost to prevent engine damage.
6. Remove the oil filler dipstick and drain the oil into a suitable container.
7. Refill with new oil of the recommended SAE viscosity grade. (Refer to-'Before Starting the Mower') (Refer fig.21)

## Air Cleaner Service

To service the air cleaner, loosen screw (1) and remove cover (2). (Refer fig.22)

Remove cartridge (3) and clean by tapping gently on a flat surface. If very dirty, replace.

- Do not use petroleum solvents.
- Do not use pressurised air.
- Do not oil the cartridge.

After servicing, install the cartridge into the cover. Insert the tabs on the bottom of the cover into the slots in the bottom of the base (4). Tilt the cover upwards and securely tighten the screw to the base.

## Spark Plug Service

Use only Briggs & Stratton (Part number 19368) spark tester (1) to check for a spark as shown in the diagram. (Refer fig.23)

Replace the spark plug every 100 hours or every season, whichever occurs first. A spark plug wrench is available from any authorised Briggs & Stratton service dealer.

Check the spark plug gap with a feeler gauge and set at 0.50mm. (Refer fig.24)

## Keeping Engine Clean

Remove all grass and debris from the engine including the exhaust/exhaust guard, the air ways in the top cowl and the surrounding deck areas on a daily basis after use. Never spray the engine with water during cleaning. Water can contaminate the fuel. Always clean with a brush or compressed air. (Refer fig.25)

Grass and debris may clog the engine's air cooling system especially after prolonged operation while cutting tall, dry grass. The internal cooling fins and surfaces may require cleaning to prevent overheating and engine damage. We recommended that this service be carried out by an authorised Hayter Service dealer.

## Grassbag

Remove grass debris from the grassbag immediately after use and check its condition for signs of damage. To prevent accidents replace a damaged grassbag immediately. (Refer fig.26)

## Deck Housing

Remove grass debris from the top and underside of the deck housing immediately after use. (Refer fig.27) Fertilisers and top dressings are particularly corrosive. Thoroughly clean the mower deck immediately after use on treated grass and store well away from corrosive materials.

Fig. 21

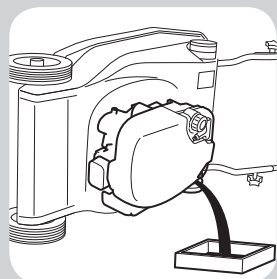

Fig. 22

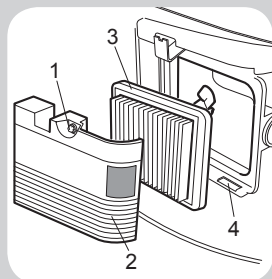

Fig. 23

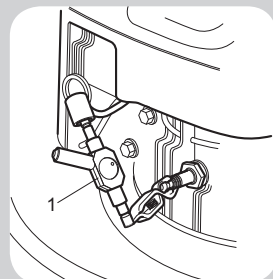

Fig. 24

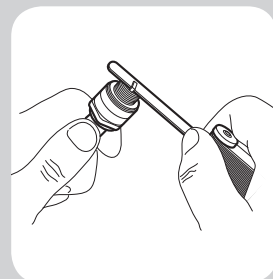

Fig. 25

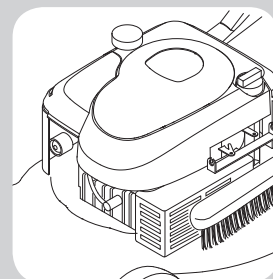

Fig. 26

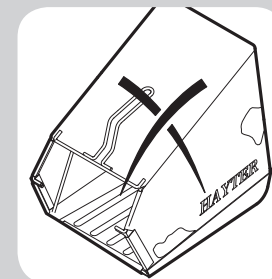
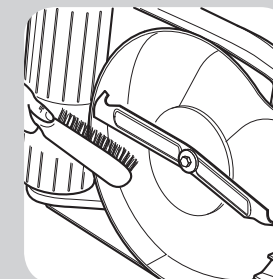

Fig. 27



# MOWER MAINTENANCE

## Securing Nuts & Bolts

Regularly check that all securing nuts and bolts are tight. Replace missing or damaged items immediately.

## Clutch Cable Adjustment

At any time the operator feels that the machine is loosing drive:

1. Stop the engine.
2. Pull the machine backwards at the same time progressively engage the clutch lever until the rear rollers lock, at this point the clutch lever should be 60mm from the handlebar.
3. If the distance between the clutch lever and handlebar is less than 60mm regulate the engagement position with the black plastic cable adjuster. To regain the 60mm distance (Refer fig.28 & 29)
4. Note this is a temporary adjustment and at the nearest opportunity a service should be carried out to ensure the spring on the clutch cable attached to the gearbox clutch is set correctly. This adjustment should be done using the metal adjuster at the control with the plastic adjuster reset fully wound in. When the spring is set tighten the inner lock nut to secure position. (Refer figs.30 & 31)

## Lubrication

Lubricate the wheels, pivot points and linkages with

engine oil every 25 operating hours.

Apply a good quality medium grease to the inner control cables at the point of entry and exit from their outer casing.

## Cutterblade Removal

Drain the fuel by running the engine until the fuel tank is empty and the engine stops. Remove the spark plug lead and allow the engine to cool. Turn the mower on its left hand side and ensure that the air cleaner side of the engine is uppermost. (Refer fig.32)

Firmly grip the end of the cutterblade with a gloved hand and remove the bolt, spring washer and distance piece securing the cutterblade with a 9/16" A/F spanner. (Refer fig.33)

**To prevent accidents never work on the cutterblade unless the spark plug lead has been removed. The cutterblade has sharp edges. ALWAYS wear strong gloves to protect your hands when working on the cutterblade. DO NOT rotate tools towards the cutting edges to avoid the risk of injury should the tool slip. ALWAYS use genuine Hayter replacement parts.**

The condition of the cutterblade and its mounting arrangement should be checked regularly for signs of wear or damage. Ensure that the cutterblade is not bent or cracked.

A damaged cutterblade that is out of balance will vibrate excessively and may break. DO NOT use an unbalanced cutterblade.

Regularly check that the bolt securing the cutterblade is tightened to the specified torque of 54Nm.

Replace the cutterblade every 2 years or sooner if excessively worn or damaged.

To prevent injury it is wise to seek assistance when turning the mower on its side.

## Cutterblade Assembly

Assemble the cutterblade with the turned up edges facing towards the engine. Secure the cutterblade using the bolt (1), spring washer (2), and distance piece (3). (Refer fig.33)

Fig. 28

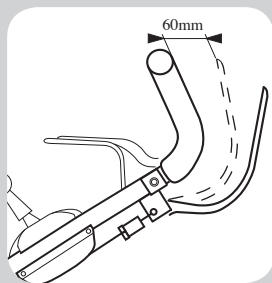

Fig. 29

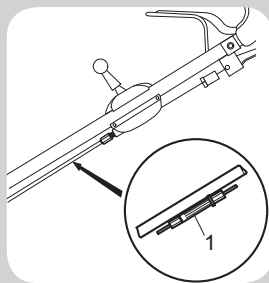

Fig. 30

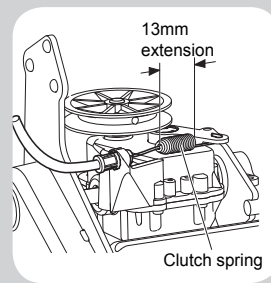

Fig. 31

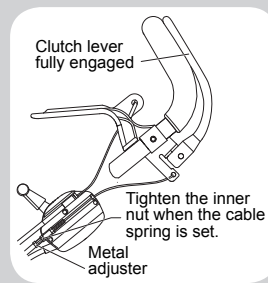

Fig. 32

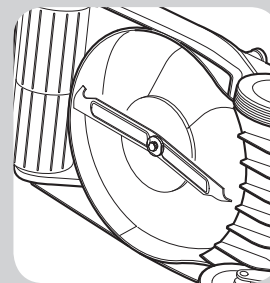
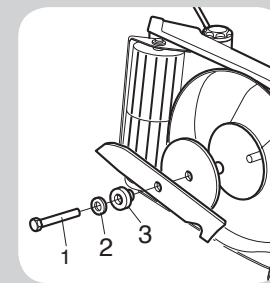

Fig. 33



# MOWER MAINTENANCE

## Cutterblade Sharpening

A slightly worn cutterblade may be re-sharpened. Both blade edges must be sharpened equally to ensure balance. Sharpen the cutterblade every 25 mowing hours or more frequently if conditions require. Remove the cutterblade from the mower and clean using a brush and water. Inspect the cutterblade for signs of damage.

Sharpen both cutting edges with a flat file to restore performance. *(Refer fig.34)*

Ensure that the cutterblade is balanced. Use a screw driver with a round shaft to support the cutterblade through its centre hole. Hold the cutterblade horizontal and then release. A balanced cutterblade will remain horizontal.

*(Refer fig.35)*

If the cutterblade is not balanced the heavy end will rotate downwards. Sharpen the heavy end until the cutterblade is correctly balanced. *(Refer fig.36)*

## Storage

To store the handlebar unscrew the 2 small securing knobs sufficiently to allow it to be pivoted forwards to rest against the mower. Take care to ensure that the control cables do not become snagged at the pivot point and depress the engine stop lever to prevent it being damaged through contact with the engine. *(Refer fig.37)*

Engines stored in excess of 30 days need to be protected with Briggs & Stratton fuel additive or drained of fuel to prevent gum from forming in the fuel system or on essential carburettor parts. To ensure your mower is maintained in good working order it is important that the following procedure is adopted. Refer to the Maintenance section as necessary.

- Drain fuel from the engine by operating the engine until it stops.
- Disconnect the spark plug lead.
- Change the engine oil.
- Remove the engine spark plug and pour 15ml of engine oil into the engine cylinder and replace the spark plug. Do not exceed the stated volume of oil as engine damage may occur on re-starting. Do not replace the spark plug lead. Slowly pull the engine start - grip once to crank the engine. This will distribute the oil and help prevent engine corrosion.
- Clean grass and debris from the engine cylinder, cylinder head cooling fins, under top cowl, around and behind exhaust/exhaust guard and ensure that the grassbag is clean.
- Lubricate the mower and treat metal parts with a water repellent anti-corrosion product.
- Cover the mower with a protective sheet and store it in a dry, ventilated area.

Fig. 34

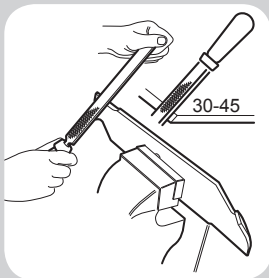

Fig. 35

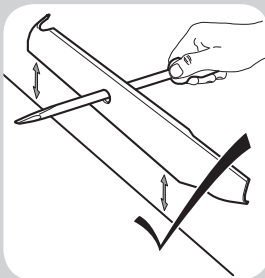

Fig. 36

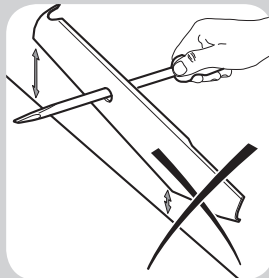
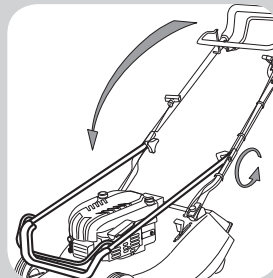

Fig. 37





# MOWER MAINTENANCE

## **Battery Charging** (Code 491 only)

- **PREVENT ACCIDENTS: ALWAYS charge the battery in a well ventilated area.**
- **NEVER charge the battery near naked flames or direct heat.**
- **ALWAYS switch off the mains electricity supply before disconnecting the charger from the battery.**
- **ALWAYS use the battery charger supplied with the mower.**
- Battery charging should not be necessary during normal use. The engine operation will automatically charge the battery. If the mower is stored for a long period recharging the battery may be necessary to permit electric starting.
- To recharge the battery: Disconnect the battery lead from the mower lead and then connect the battery lead to the charger.
- Connect the charger plug to the mains electricity supply and switch on to charge the battery for a fourteen hour period. *(Refer fig.38)*
- Disconnect the battery lead from the charger and then

connect the battery lead to the mower lead.

**IMPORTANT - PREVENT DAMAGE: NEVER connect the battery charger to the engine lead as this will cause the charger to be permanently damaged. Chargers damaged in this manner will not be replaced under warranty.**

**CAUTION - PREVENT ENVIRONMENTAL DAMAGE.** *(Refer fig.39)*

**The battery and charger have a separate collection mark.**

**This indicates that for disposal of the battery and battery charger they must be taken to an authorised disposal site. They must not be disposed of with general waste.**

EU Directive 2002/96/EC classifies these products as electrical or electronic equipment. (a) These products should not be disposed of as unsorted municipal waste. *(Refer fig.39)*

(b) They should be taken to a designated collection point or recycling centre and handled according to national laws in the area.

(c) The consumer has a critical role in returning waste

electronic/electrical equipment for recycling and disposal.

(d) Recycling keeps these products out of the municipal waste stream.

(e) The crossed-out bin symbol is a reminder to follow these points.

(f) Please contact your local authority or local dealer and ask for further details regarding the correct method of disposal.

Fig. 38

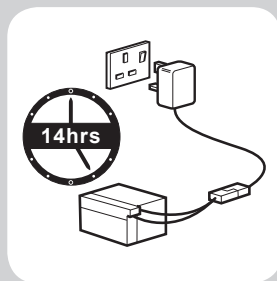

Fig. 39





# LAWN CARE CALENDAR To be used as a guide only

## **January**

There is very little work to do this month apart from brushing away leaves. Keep off the grass if frozen or waterlogged.

## **February**

Rake the grass thoroughly. Spike the lawn to aerate and stimulate soil organisms and root growth and apply lawn sand if necessary.

## **March**

The yearly lawn work programme really starts this month. As soon as the ground conditions are suitable, the first cut can be made. The first cut should merely “top” the grass as close cutting at this stage could result in severe yellowing or browning. Two cuts are generally sufficient this month.

## **April**

Mow often enough to stop grass growing away. Dig out patches of coarse grass or resistant weed. Re-seed bare patches.

## **May**

Keep mowing increasing the frequency as required. Treat with selective weed killers or combined weed/feed preparations if you did not feed the lawn in April.

## **June**

Summer mowing should now be under way. It should be necessary to mow the lawn twice a week. Raking before mowing is important this month as the combined action keeps runners of clover under control. Water the grass if necessary, and remember to soak thoroughly.

## **July**

Treat the grass with the second application of fertiliser or weed killer/fertiliser. Water when necessary and rake occasionally. As a general rule the grass clippings should be removed each time you mow. If weather conditions are dry and hot and the grass is weed free, leave the clippings on the lawn to help maintain ground moisture.

## **August**

Keep mowing regularly and watering as necessary. Fill any cracks caused by drought with a mixture of sharp sand and soil. In dry weather conditions leave the grass longer to help retain ground moisture.

## **September**

Raise the height of cut to allow the grass to thicken and protect the roots from the winter frost and snow.

## **October**

Rake out the thatch from the turf and spike the lawn to assist in drainage. Brush in peat and sharp sand.

## **November**

Use a stiff broom to disperse worm casts before mowing. Keep turf free from leaves.

## **December**

Apart from brushing away leaves, December is a slack end of a busy year. Keep off the lawn if it is very wet or frozen.

## **Lawn Stripes**

The way to achieve a neat striped effect is for the lawn being cut in parallel stripes, alternate stripes being mown in opposite directions. A much more important routine is to cut at right angles to the line of the previous mowing. If the work has been carried in a north-south line, then the next cutting should be in an east-west direction. The cross-cutting keeps down the coarse weed grasses.

**To prevent grass damage do not remove more than one third of the grass height in one cut.**

# TROUBLE SHOOTING

PROBLEM	CAUSES	CORRECTIVE ACTION
Engine will not turn over	<ol style="list-style-type: none"> <li>1. Engine stop lever released</li> <li>2. Incorrect oil level</li> <li>3. Obstruction under deck</li> <li>4. Battery discharged (if fitted)</li> </ol>	<ol style="list-style-type: none"> <li>1. Operate engine stop lever</li> <li>2. Check oil level</li> <li>3. Remove obstruction</li> <li>4. Charge battery</li> </ol>
Engine smokes	<ol style="list-style-type: none"> <li>1. Excess oil</li> <li>2. Air cleaner cartridge oil soaked or blocked</li> </ol>	<ol style="list-style-type: none"> <li>1. Check oil level</li> <li>2. Service air cleaner</li> </ol>
Engine runs then stops	<ol style="list-style-type: none"> <li>1. Fuel starvation</li> <li>2. Fuel cap vent blocked</li> </ol>	<ol style="list-style-type: none"> <li>1. Fill fuel tank</li> <li>2. Clean fuel cap vent</li> </ol>
Engine will not start	<ol style="list-style-type: none"> <li>1. Engine under load</li> <li>2. Incorrect/contaminated fuel</li> <li>3. Spark plug lead disconnected</li> <li>4. Engine brake not released</li> <li>5. Faulty spark plug</li> <li>6. Battery discharged (if fitted)</li> <li>7. Wiring fault</li> </ol>	<ol style="list-style-type: none"> <li>1. Raise height of cut</li> <li>2. Drain tank and fill with correct fuel</li> <li>3. Connect spark plug lead</li> <li>4. Operate engine brake lever</li> <li>5. Clean and adjust the gap or replace</li> <li>6. Charge battery</li> <li>7. Check wiring</li> </ol>
Engine runs rough	<ol style="list-style-type: none"> <li>1. Spark plug lead becoming disconnected in use</li> <li>2. Faulty spark plug</li> <li>3. Air cleaner blocked</li> <li>4. Incorrect/contaminated fuel</li> </ol>	<ol style="list-style-type: none"> <li>1. Connect spark plug lead</li> <li>2. Clean and adjust gap or replace</li> <li>3. Service air cleaner</li> <li>4. Drain tank and fill with correct fuel</li> </ol>
Engine vibrates excessively	<ol style="list-style-type: none"> <li>1. Mounting bolt loose</li> <li>2. Cutterblade bolt loose</li> <li>3. Cutterblade out of balance</li> <li>4. Bent Crankshaft</li> </ol>	<ol style="list-style-type: none"> <li>1. Tighten bolts</li> <li>2. Tighten bolt</li> <li>3. Balance cutterblade</li> <li>4. Consult your dealer</li> </ol>
Uneven cut	<ol style="list-style-type: none"> <li>1. Undulating ground conditions</li> <li>2. Cutterblade worn</li> <li>3. Cutterblade out of balance</li> <li>4. Wheels/roller damaged</li> </ol>	<ol style="list-style-type: none"> <li>1. Change direction of travel</li> <li>2. Sharpen cutterblade</li> <li>3. Balance the cutterblade</li> <li>4. Insect &amp; replace as necessary</li> </ol>

PROBLEM	CAUSES	CORRECTIVE ACTION
Discharge chute blocks	<ol style="list-style-type: none"> <li>1. Grass is wet</li> <li>2. Cut height is too low</li> <li>3. Grassbag full</li> <li>4. Airflow through the grassbag is restricted</li> </ol>	<ol style="list-style-type: none"> <li>1. Mow dry grass</li> <li>2. Increase cut height</li> <li>3. Empty grassbag</li> <li>4. Clean the grassbag</li> </ol>
Mower is hard to push	<ol style="list-style-type: none"> <li>1. Cut height too low</li> <li>2. Wheels/roller damaged</li> </ol>	<ol style="list-style-type: none"> <li>1. Increase cut height</li> <li>2. Inspect and replace as necessary</li> </ol>
Mower will not self propel	<ol style="list-style-type: none"> <li>1. Clutch out of adjustment</li> <li>2. Drive belt damaged</li> </ol>	<ol style="list-style-type: none"> <li>1. Adjust clutch cable</li> <li>2. Replace drive belt</li> </ol>
Poor grass collection	<ol style="list-style-type: none"> <li>1. Airflow through the grassbag is restricted</li> <li>2. Discharge chute blocked</li> <li>3. Wet grass</li> <li>4. Grassbag full</li> </ol>	<ol style="list-style-type: none"> <li>1. Clean the grassbag</li> <li>2. Remove blockage</li> <li>3. Mow in dryer conditions</li> <li>4. Empty grassbag</li> </ol>
Cutterblade drive will not engage/disengage	<ol style="list-style-type: none"> <li>1. Engine stop lever not fully forward</li> </ol>	<ol style="list-style-type: none"> <li>1. Push fully forward disengage</li> </ol>

Hayter Limited warrants to the original user/purchaser that this unit shall be free from defects in material and workmanship under normal use and service for a period of three years from the date of purchase. The manufacturer of major proprietary components ie. engines, gearbox / transaxle (where applicable) furnish their own warranty and services are provided through their authorised network. To qualify for the full benefit of the warranty, the warranty registration card must be returned within 14 days of purchase. Subject to the conditions and exclusions noted in this limited warranty, we shall at our option, repair or replace any warranted part during the applicable period. If you are in doubt or experience any difficulty, please consult a Hayter Authorised Service Dealer for clarification.

To qualify for the extended warranty (second and third year) of the three year limited warranty the machine must have annual services carried out by an Authorised Hayter Service Dealer. These chargeable services should be carried out within 12 and 24 months of the date of purchase.

Excluded from the extended warranty period are those items which are subject to normal wear and tear e.g. tyres, wheels, cutterblades, belts, cables, grassbags, sweeper/brushes, batteries and other consumable wearing parts.

All consumer machines which are fitted with a genuine Hayter friction disc as original equipment before use, are covered by a Lifetime Warranty against the engine crankshaft bending. Note: friction washers, blade brake clutch (B.B.C) units and other such devices are not applicable. Only machines fitted with a genuine Hayter friction disc, which are used in accordance with the recommended operating and maintenance procedures, are covered.

This warranty does not apply to any unit that has been tampered with, altered, misused, abused or used for hire, and will become invalid if non genuine Hayter parts are fitted. This warranty does not cover minor mechanical adjustments unless they are due to defective material or workmanship. Consult the Owner's Handbook or a Hayter Authorised Service Dealer for assistance when making these adjustments.

A warranty period of 90 days applies to machines used for commercial purposes.

To make a warranty claim, return the unit to a Hayter authorised dealer along with proof of purchase stating the machine serial number and date of purchase. The service receipt(s) or this Owners Handbook with the 1st/2nd year service boxes fully completed, must be produced as proof of entitlement to the extended warranty period. Subject to the conditions and exclusions in this limited warranty, the authorised dealer will, at our option, repair or replace any warranted part within the duration of the warranty period.

This limited warranty gives you specific legal rights and is in addition to any statutory rights to which you may be entitled and your statutory rights are not affected by this warranty. If you need additional information concerning this written warranty, or assistance in obtaining services, please write to : HAYTER LIMITED, Service Department, Spellbrook, Bishop's Stortford, Hertfordshire CM23 4BU

UK ONLY: Details of your local Hayter authorised dealer are contained in Yellow Pages and the Hayter website [www.hayter.co.uk](http://www.hayter.co.uk) or contact contact:- Freephone 0800 616298.

Issue: 01.09.09

*NOTES*

*NOTES*

*NOTES*

*NOTES*

# CUSTOMER INFORMATION

CODE

SERIAL NO.

Engine Type:-

Engine:-

Date of Sale:- \_\_\_\_\_

Your Local Dealer:-

DEALER STAMP



Hayter Limited, Spellbrook, Bishop's Stortford, Herts, CM23 4BU, England  
Website: [www.hayter.co.uk](http://www.hayter.co.uk)

# SERVICE RECORD



1st Year (12 months)

We certify that this service has been carried out by an Authorised Hayter Service Dealer

Date: \_\_\_\_\_

DEALER STAMP



2nd Year (24 months)

We certify that this service has been carried out by an Authorised Hayter Service Dealer

Date: \_\_\_\_\_

DEALER STAMP



1st Year (12 months)

Owner's Name: \_\_\_\_\_

Serial Number: \_\_\_\_\_

Date: \_\_\_\_\_

DEALER STAMP

Note for dealer: Please retain this voucher for your records.



2nd Year (24 months)

Owner's Name: \_\_\_\_\_

Serial Number: \_\_\_\_\_

Date: \_\_\_\_\_

DEALER STAMP

Note for dealer: Please retain this voucher for your records.